



TERMA

SINCE 1990



◀ **Heizkörper**

ROLO HANGER 1800 ↑ x 205 ↔ SX,
Farbe der Heizkörper: RAL 9016,
Code Heizkörper: WGROW180020 K916SX

Ventile und Zubehör

Set winkeleck-regelventil, Chrom

ROLO HANGER







VERFÜGBARE GRÖSSEN



2

1200 x 90
↓ ↔



3

1200 x 150



4

1200 x 205

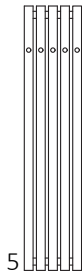

5

1200 x 260

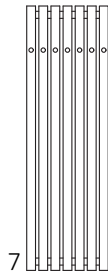

7

1200 x 370

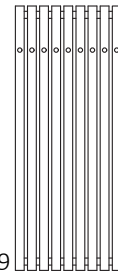

9

1200 x 480

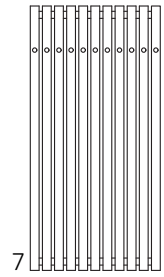

7

1200 x 590



2

1800 x 90
↓ ↔



3

1800 x 150



4

1800 x 205



5

1800 x 260

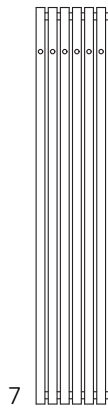

7

1800 x 370

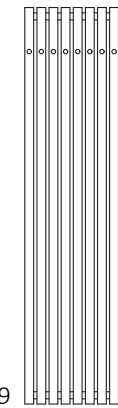

9

1800 x 480

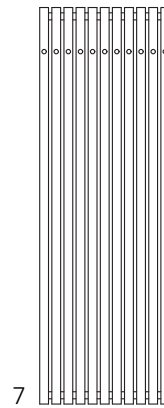

7

1800 x 590

HEIZKÖRPER ZUM ANSCHLUSS AN ZENTRALHEIZUNG

Anschlussstypen



Höhe A ↕ [mm]	Breite B ↔ [mm]	Heizleistung			Artikelnummer <small>... Konfigurations codes.7</small>
		75/65/20°C [W]	55/45/20°C [W]	[W]	
1200	95	162	82	200	WGROW120009
1200	150	242	122	300	WGROW120015
1200	205	323	163	300	WGROW120020
1200	260	404	204	400	WGROW120026
1200	370	565	285	600	WGROW120037
1200	480	726	366	800	WGROW120048
1200	590	888	447	800	WGROW120059
1800	95	237	118	300	WGROW180009
1800	150	356	177	400	WGROW180015
1800	205	474	235	600	WGROW180020
1800	260	573	284	600	WGROW180026
1800	370	802	398	800	WGROW180037
1800	480	1 031	512	1000	WGROW180048
1800	590	1 260	625	1200	WGROW180059

ABMESSUNGEN UND TECHNISCHE INFORMATIONEN

Betriebsdruck: 1000 kPa

Maximale Betriebstemperatur: 95°C

Höhe A ↕ [mm]	Breite B ↔ [mm]	Nabenabstand C2 [mm]	Nabenabstand C3 [mm]	Horizontaler Abstand der Wandhalterungen D [mm]	Vertikaler Abstand der Wandhalterungen E [mm]	Position der unteren Wandhalterung F [mm]	Kapazität [dm³]	Gewicht [kg]
1200	95	55	1120	55	960	120	2,71	3,99
1200	150	110	1120	110	960	120	4,08	5,90
1200	205	165	1120	165	960	120	5,44	7,81
1200	260	220	1120	220	960	120	6,81	9,72
1200	370	330	1120	330	960	120	9,54	13,54
1200	480	440	1120	440	960	120	12,27	17,35
1200	590	550	1120	550	960	120	15,00	21,18
1800	95	55	1720	55	1 560	120	4,00	5,82
1800	150	110	1720	110	1 560	120	6,01	8,66
1800	205	165	1720	165	1 560	120	8,02	11,51
1800	260	220	1720	220	1 560	120	10,03	14,35
1800	370	330	1720	330	1 560	120	14,06	19,99
1800	480	440	1720	440	1 560	120	18,08	25,63
1800	590	550	1720	550	1 560	120	22,10	31,28

TECHNISCHE ZEICHNUNG

SX

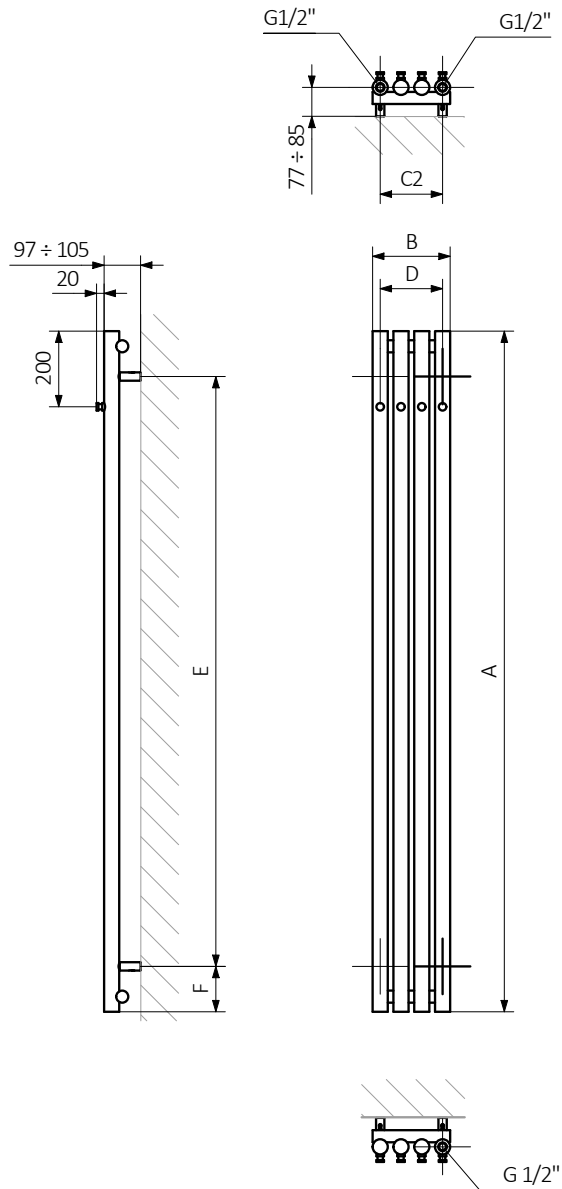

A – Höhe B – Breite C1-C5 – Anschlussabstand D – horizontaler Wandhalterungsabstand E – Vertikaler Wandhalterungsabstand F – Abstand von der Achse der unteren Wandhalterung bis Unterkante des Kollektors

Kollektor: **Rohr:**

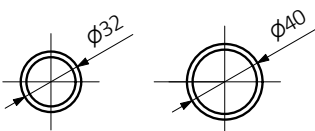

AUFBAU DES KONFIGURATIONSCODES FÜR WASSERHEIZKÖRPER (PRODUKTGRUPPE „WG“)

Den Produktcode finden Sie in den Tabelle mit den technischen Daten im Katalog / in der Preisliste. Sie enthalten grundlegende Informationen über die Produkte. Um die Eigenschaften eines Produktes zu präzisieren muss der Produktcode um einen Konfigurationscode ergänzt werden. Bei der Bestellung sollten die Artikelnummern den vollständigen Konfigurationscode enthalten. Der Konfigurationscode sollte nach dem Produktcode platziert werden, wie in folgendem Beispiel dargestellt:

ARTIKELNUMMER:

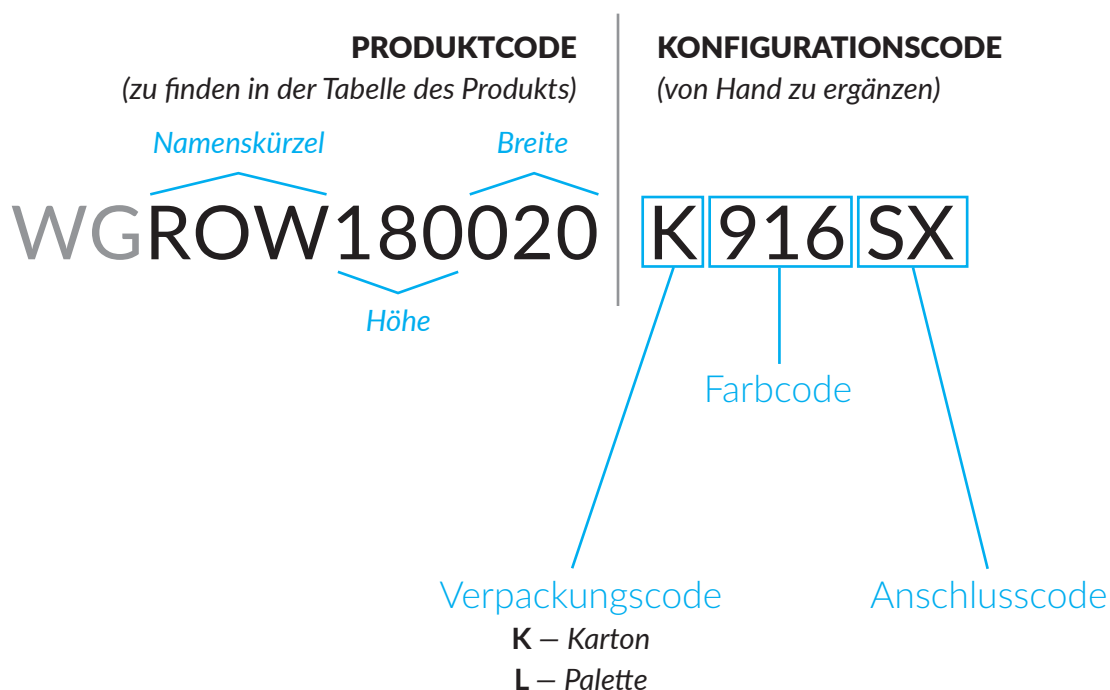

WG – Wasser- oder Kombiheizkörper zum Anschluss an eine Zentralheizung